

myone



**watertight
sliding doors**

LUCE W

The Works series models are ideal in situations where weather conditions are particularly harsh, for example on boats, or where a high level of hygiene is required. The supporting profile and cover, components and screws are made entirely of AISI 316L stainless steel, ensuring maximum resistance. The box containing the motor and the electronics is IP65 rated and ensures maximum water- and dust-tightness. Available in single-leaf (up to 200 kg) or double-leaf (up to 130+130 kg) versions.

LUCE WORKS



↓ download LUCE WOKS instructions and certificates

www.myoneautomation.com

Operator for sliding doors with three-wheeled carriages, which ensures that the doors are very stable and easy to adjust, both in height and depth. The supporting profile and cover, components and screws are made entirely of AISI 316L stainless steel. The box protecting the motor and control unit is IP65 rated. The operator has a control unit with LED alphanumeric display, full-range switching power supply (100-240 V 50/60 Hz) and battery charger.

The presence of a USB connector makes it quick and easy to update the firmware as well as to copy parameters and operating logics to a new system instantly. Continuous operation guaranteed.

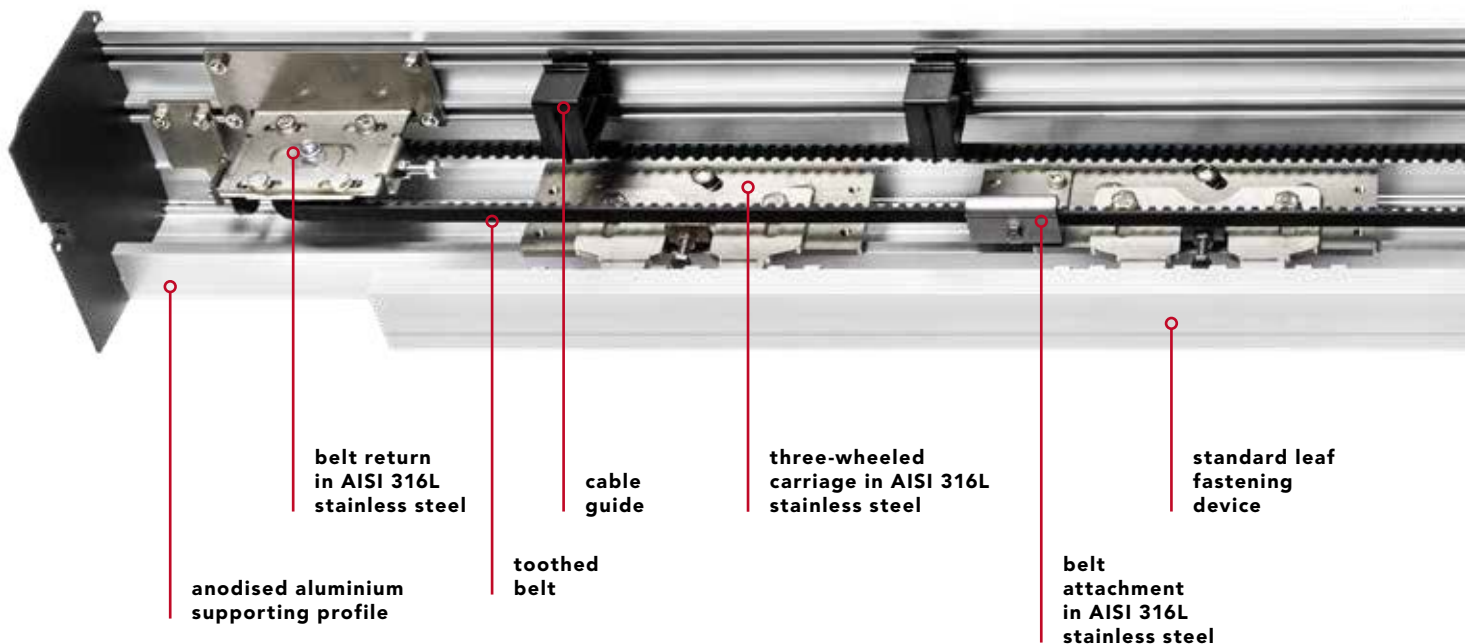

technical data

power supply	full range 100÷240 Vac 50/60 Hz
power consumption	70 W
power consumption in stand-by	3 W
accessories power supply	24 Vdc = / 1 A max
maximum speed 1 door	0.8 m/s
maximum speed 2 doors	1.6 m/s
maximum load 1 door	200 kg
maximum load 2 doors	130 + 130 kg
type and frequency of use	continuous operation = 100%
operating temperature	-15°C / +50°C
protection degree	IP65
data backup memory	USB flash drive



1 leaf
max. weight
200 kg



2 leaves
max. weight
130 + 130 kg



watertight preassembled

*The values of the passage size (A) and of the leaf are indicative and include an overlap of around 50 mm.

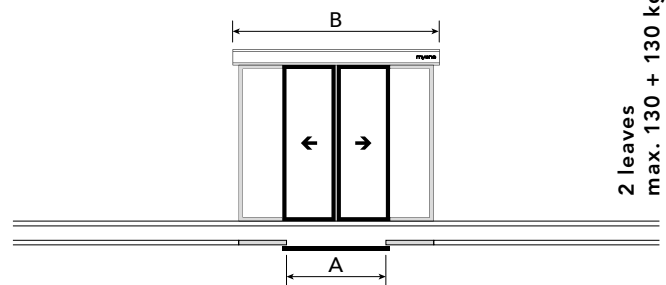
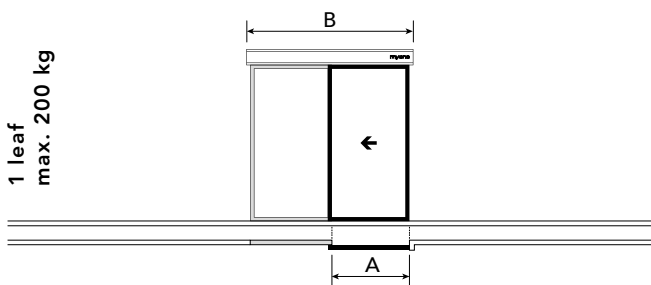

	A	B
LUCEW1901C	900 mm	1900 mm
LUCEW2101C	1000 mm	2100 mm
LUCEW2501C	1200 mm	2500 mm
LUCEW2901C	1400 mm	2900 mm
LUCEW3301C	1600 mm	3300 mm
LUCEW3701C	1800 mm	3700 mm
LUCEW4201C	2000 mm	4200 mm
LUCEW5001C	2450 mm	5000 mm
LUCEW6501C	3100 mm	6500 mm

	A	B
LUCEW1902C	900 mm	1900 mm
LUCEW2102C	1000 mm	2100 mm
LUCEW2502C	1200 mm	2500 mm
LUCEW2902C	1400 mm	2900 mm
LUCEW3302C	1600 mm	3300 mm
LUCEW3702C	1800 mm	3700 mm
LUCEW4202C	2000 mm	4200 mm
LUCEW5002C	2450 mm	5000 mm
LUCEW6502C	3100 mm	6500 mm

the preassembled operator is made up of:

control unit | gear motor with encoder | three-wheeled sliding carriages made of AISI 316L stainless steel | anodised aluminium supporting profile and cover | belt return made of AISI 316L stainless steel | mechanical end-stop made of AISI 316L stainless steel | standard leaf fastening device | belt | cable guide | screw kit | lateral sides

framed door accessories - myone frame



01FE0018

Floor guide slider.

framed door accessories - commercial frame



01AL0011

Aluminium floor guide.



01FE0018

Floor guide slider.



01AL0003

Standard leaf fastening device only required for commercial framed doors. - *already included in preassembled version*

glass door accessories - fastening set for glass leaves



99AC0004

Fastening set for glass leaf (10-12 mm) with pre-drilled holes.

- L. 1000 mm



99AC0005

Fastening set for glass leaf (10-12 mm) with pre-drilled holes.

- L. 1500 mm



99AC0006

Fastening set for glass leaf (10-12 mm) with pre-drilled holes.

- L. 2000 mm



01FE0049

Glass door slider.

- 6 piece pack



01FE0050

Glass door stainless steel slider.

glass door accessories - fastening clamp set for glass leaves



99AC0001

Fastening clamp set for glass leaf (10-12 mm thickness).

- L. 1000 mm

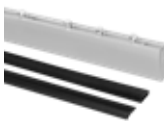

99AC0002

Fastening clamp set for glass leaf (10-12 mm thickness).

- L. 1500 mm

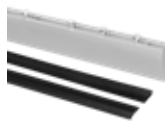

99AC0003

Fastening clamp set for glass leaf (10-12 mm thickness).

- L. 2000 mm



01FE0049

Glass door slider.

- 6 piece pack



01FE0050

Glass door stainless steel slider.

accessories



01FE0052C

Cover support brackets.

operator cross-section
technical drawing

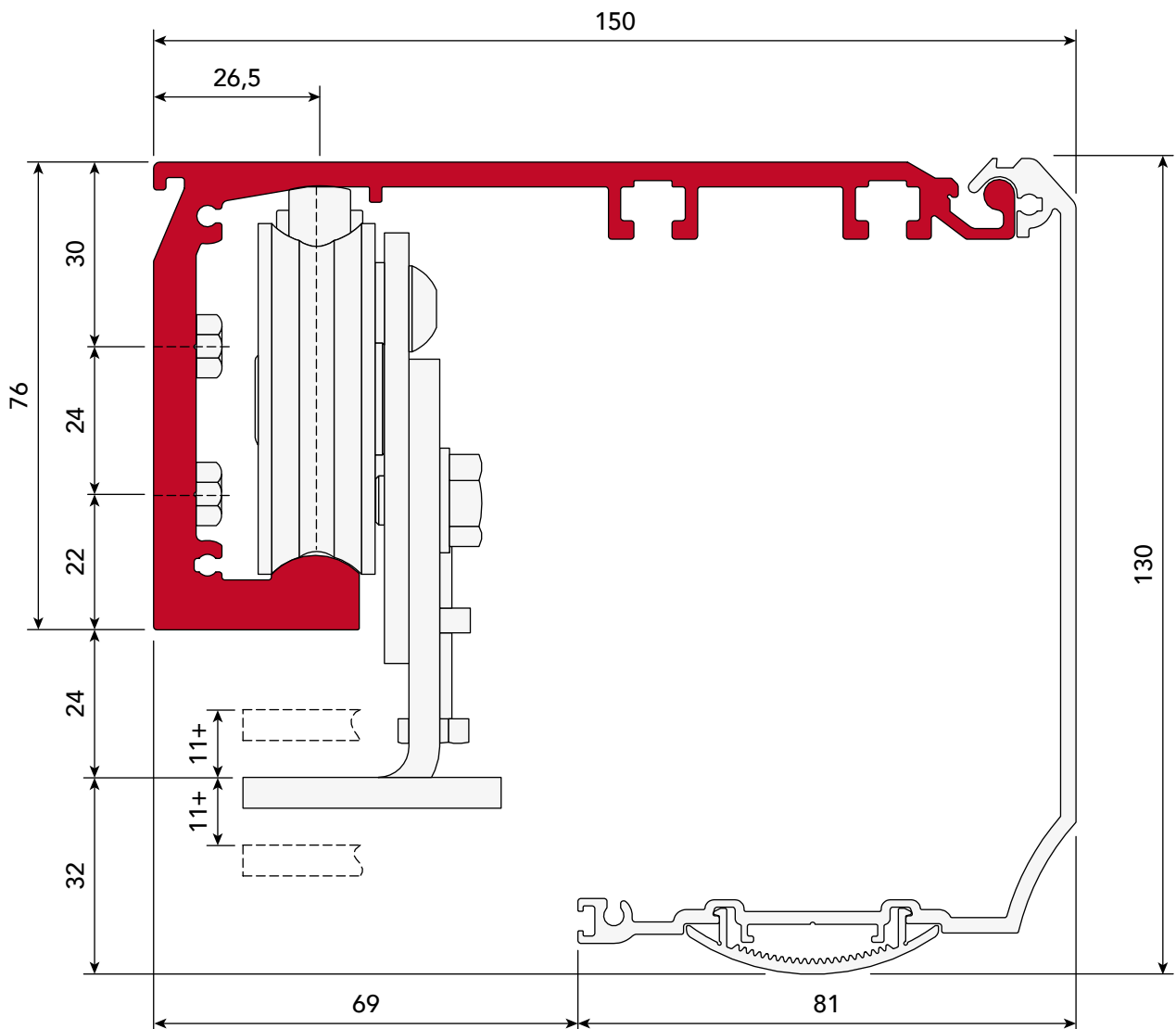

entrance with M30
myone frame

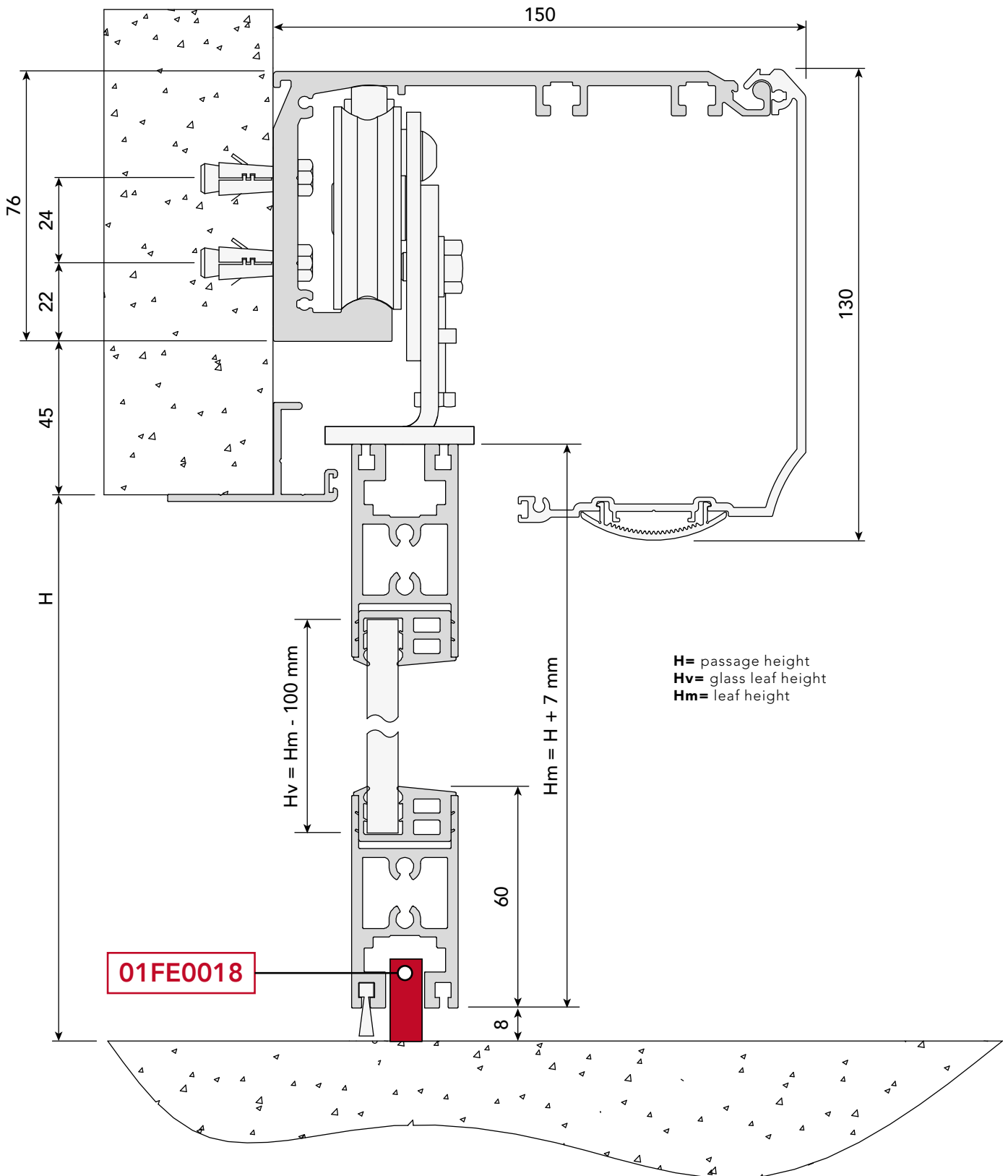

entrance with commercial profiles

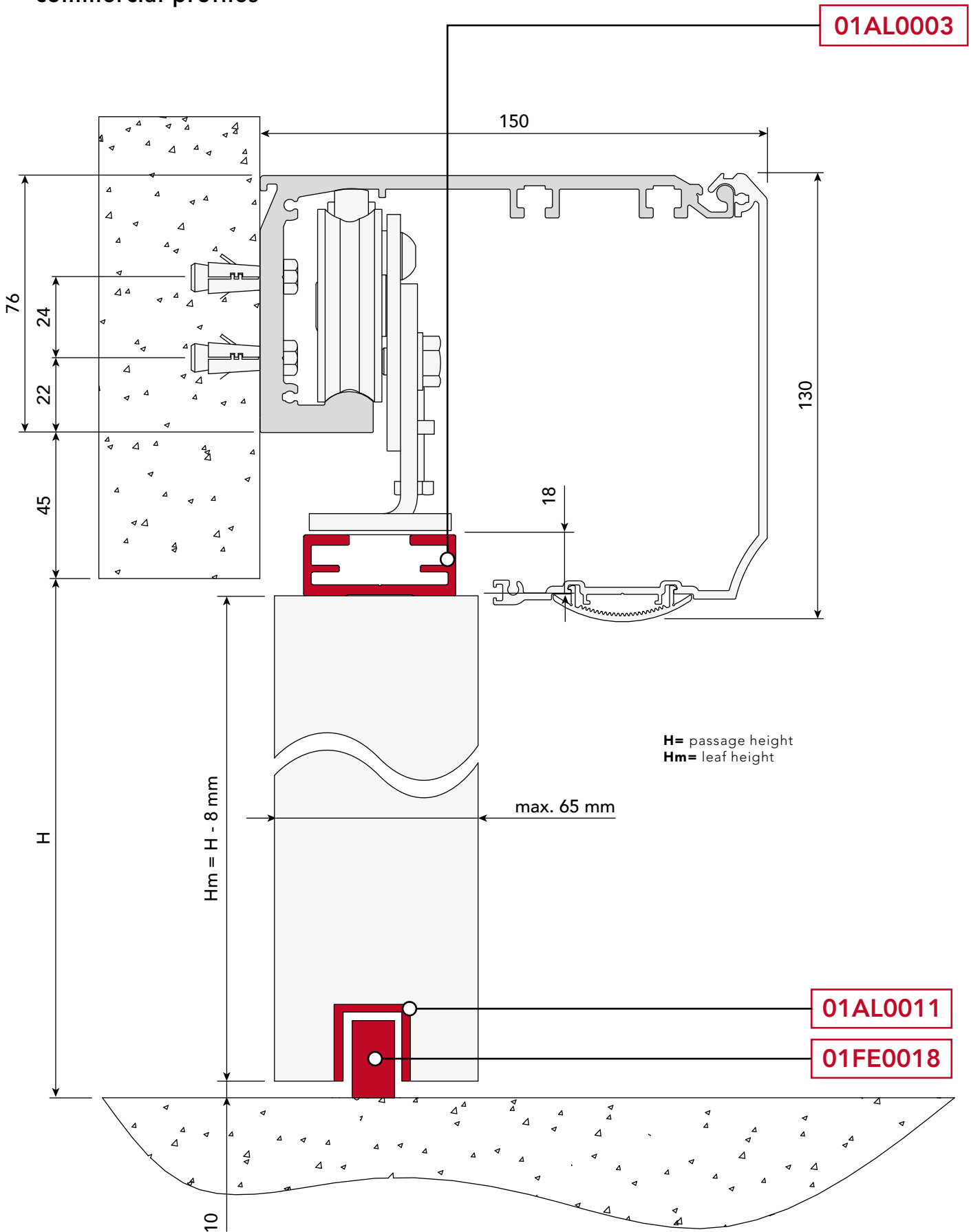

entrance with fastening set
for glass leaf with pre-drilled holes

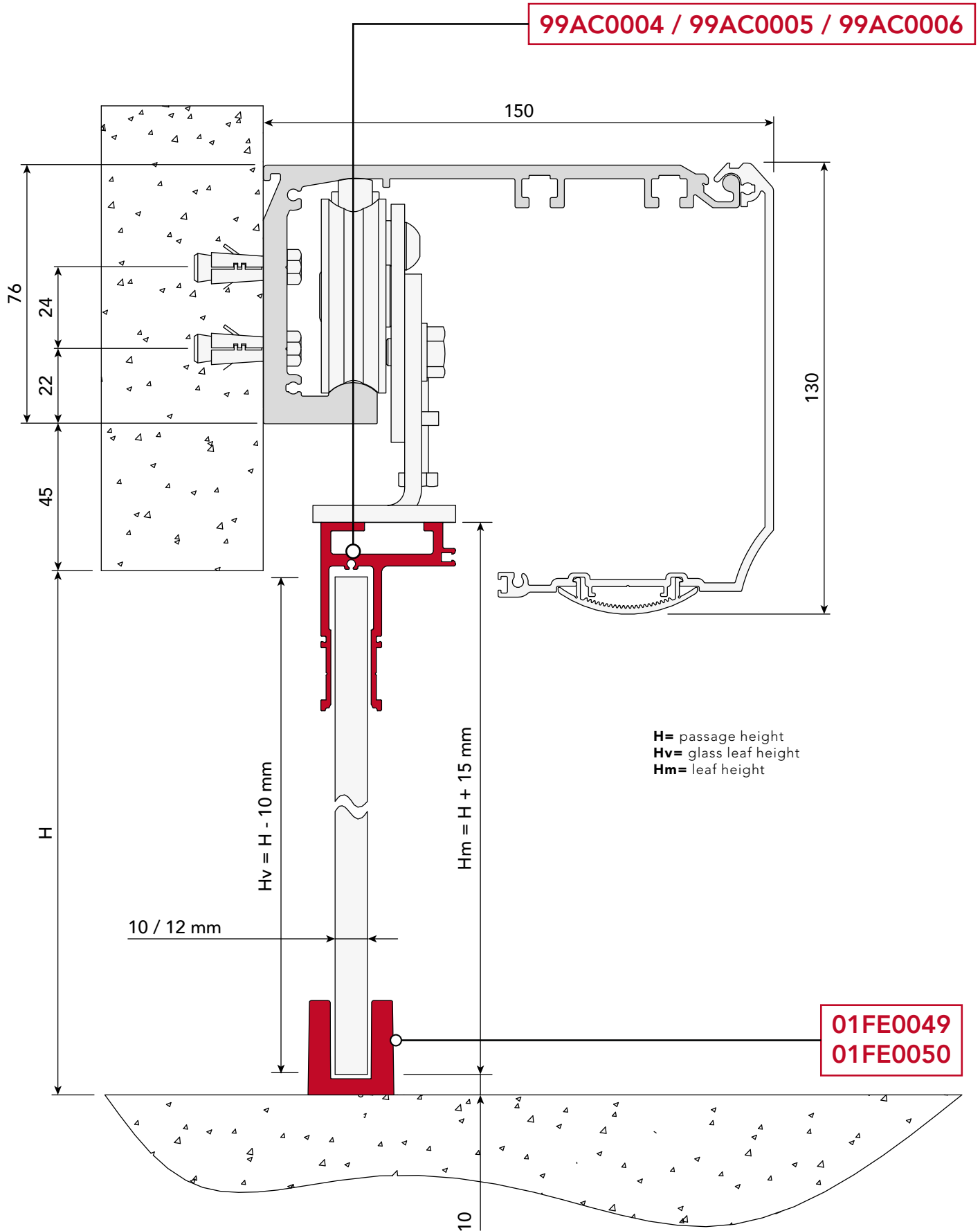

entrance with fastening set for glass leaf to clamp

99AC0001 / 99AC0002 / 99AC0003

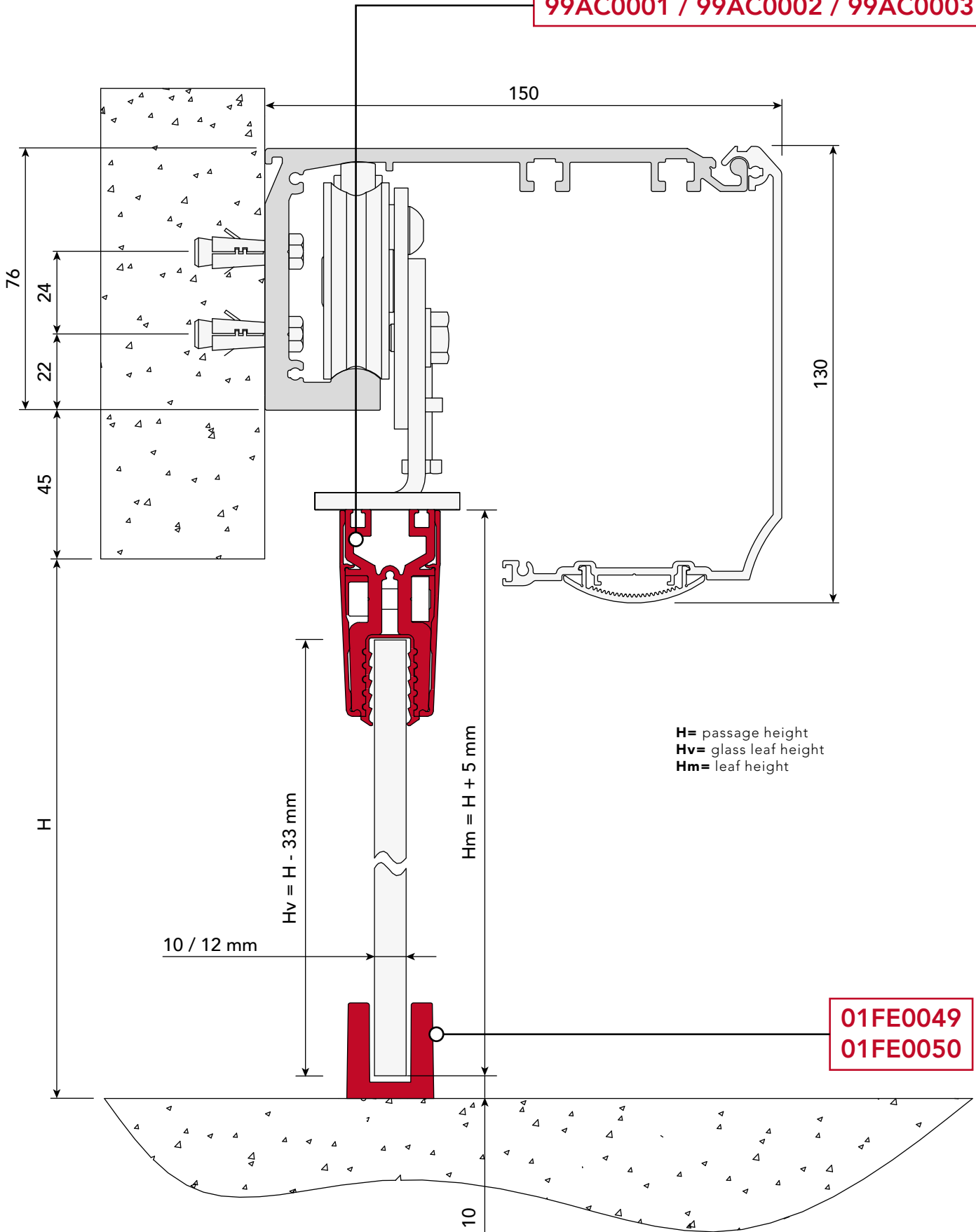

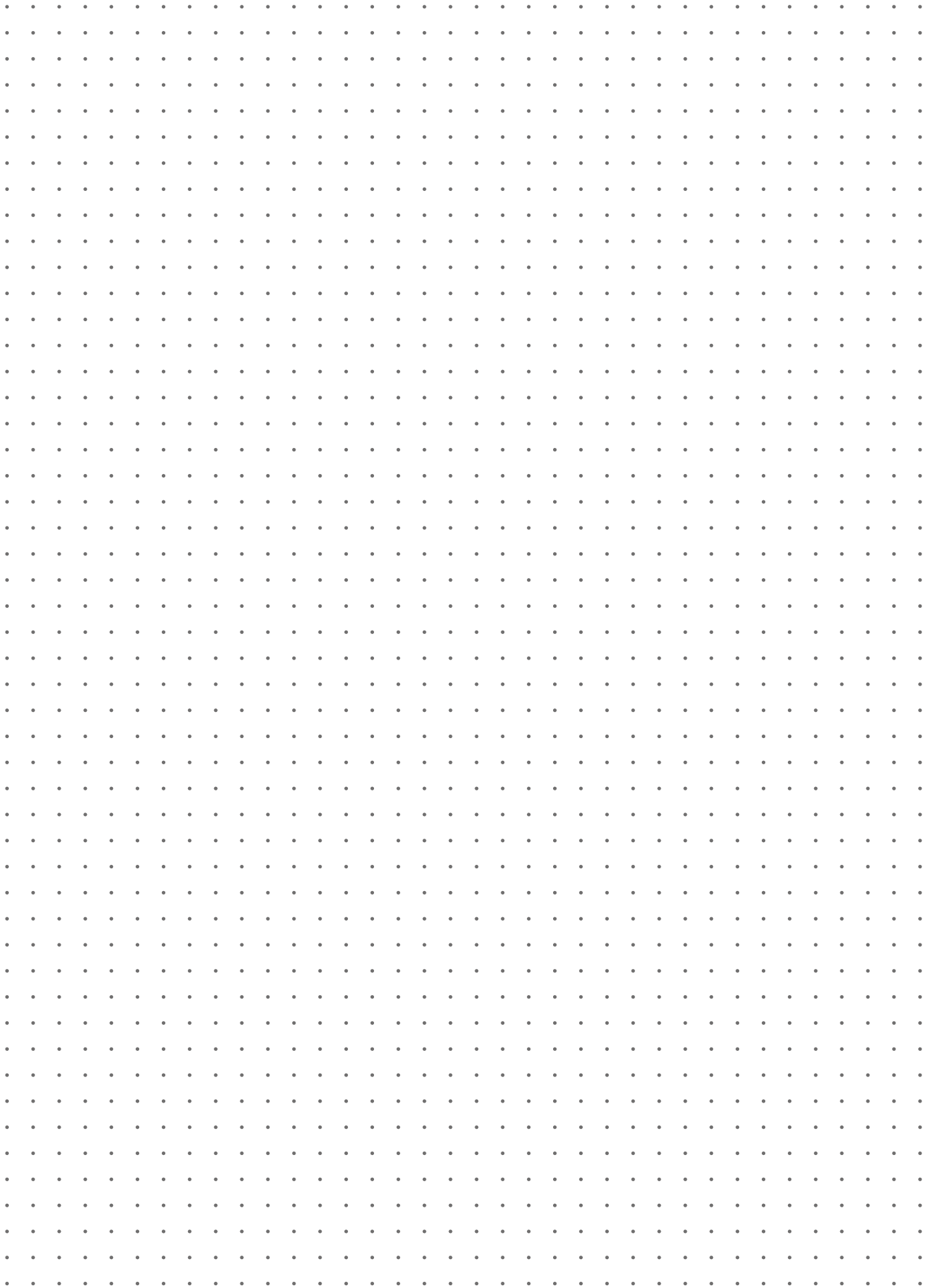

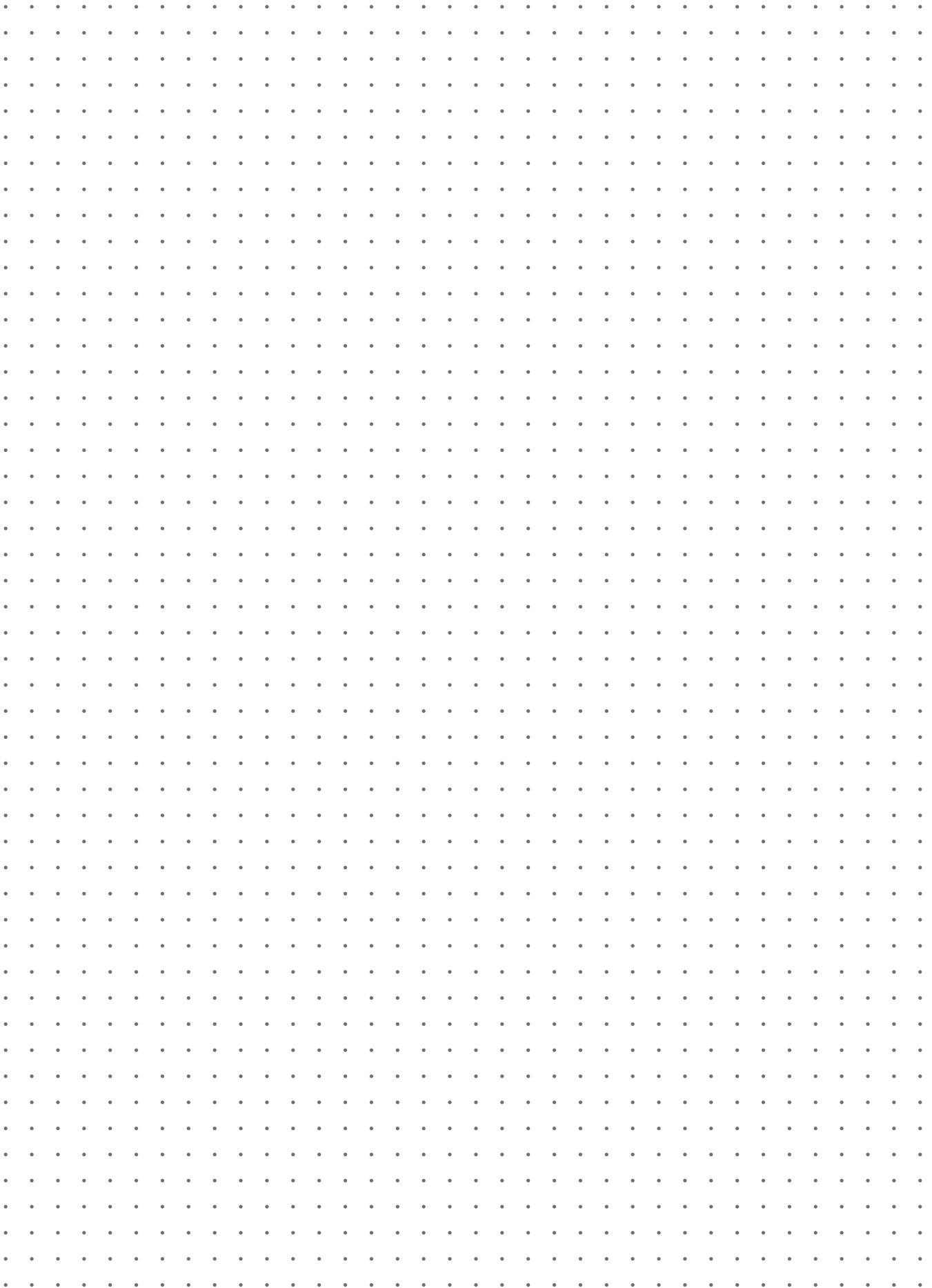



MYONE S.r.l

Via Abbate Tommaso, 52
30020 Quarto D'Altino (VE) ITALY

T +39 0422 824384

info@myoneautomation.com
www.myoneautomation.com